

PER:
FOR:

ABLOY (S)

OPTIONAL

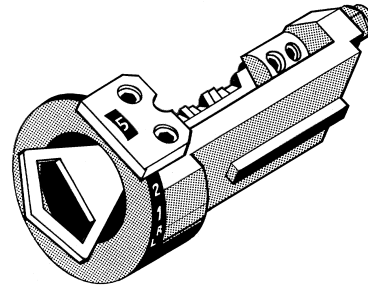
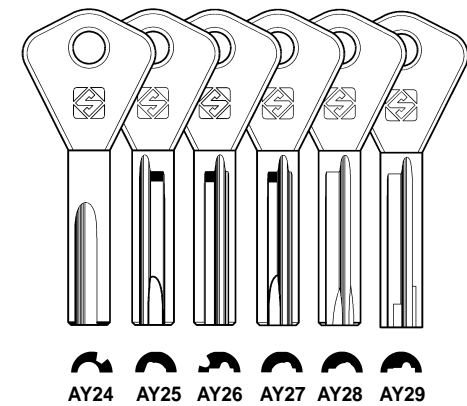
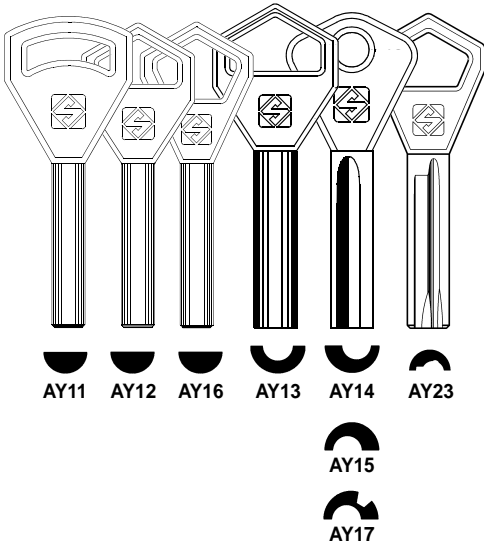
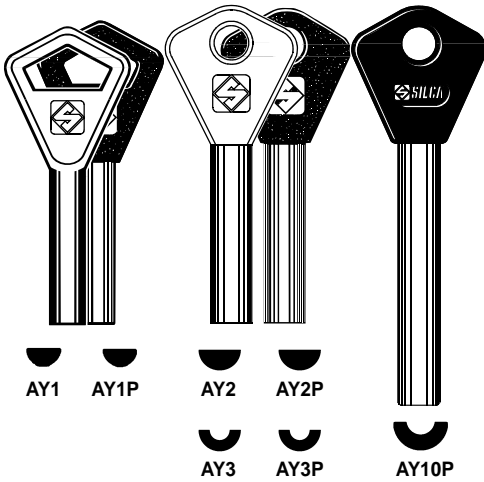

D708708ZB

Code attachment for ABLOY keys
Dispositivo a codice per chiavi ABLOY
Code-Vorrichtung für ABLOY Schlüssel
Dispositif à code pour clés ABLOY
Dispositivo a código para llaves ABLOY
Dispositivo por código para chaves ABLOY

D705040ZB

Cutter 06 (HSS)
Fresa 06 (HSS)
Fräser 06 (HSS)
Fraise 06 (HSS)
Fresa 06 (HSS)
Fresa 06 (HSS)

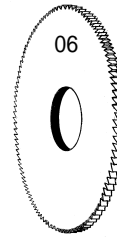

D706128ZB

Cutter 06W (carbide)
Fresa 06W (metal duro)
Fräser 06W (Hartmetall)
Fraise 06W (au carbure)
Fresa 06W (metal duro)
Fresa 06W (metal duro)

*It's advisable the use of hard metal cutter.
E' consigliato l'uso della fresa in metallo duro.
Die Fräser aus Hart Metall ist empfehlenswert.
Il est conseillé l'usage de la fraise au carbure.
Es recomendado el uso de la fresa en metal duro.
Recomendamos o uso de fresa en metal duro.*

PER:
FOR:

ABUS (D)

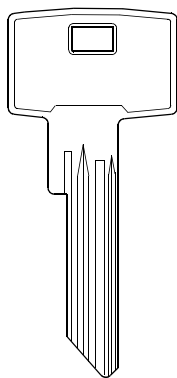

XY14
V14
Y14

CARD 2658
SN 3771

PFAFFENHAIN (D)

OPTIONAL

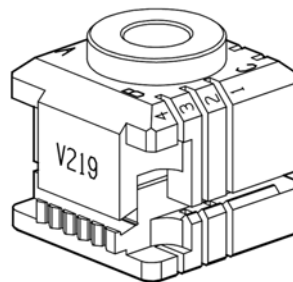

D739764ZB

Clamp V219
Morsetto V219
Spannbacken V219
Étau V219
Mordaza V219
Mordente V219

PER:
FOR:

ANCHOR LÅS (S)

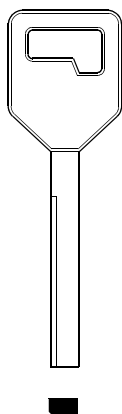

OPTIONAL

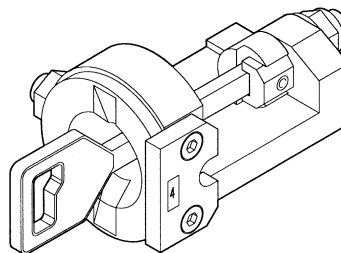

D708275ZB

Code attachment for ANCHOR LÅS keys
Dispositivo a codice per chiavi ANCHOR LÅS
Code-Vorrichtung für ANCHOR LÅS Schlüssel
Dispositif à code pour clés ANCHOR LÅS
Dispositivo a código para llaves ANCHOR LÅS

PER:
FOR:

ASSA (S) (+ various...)

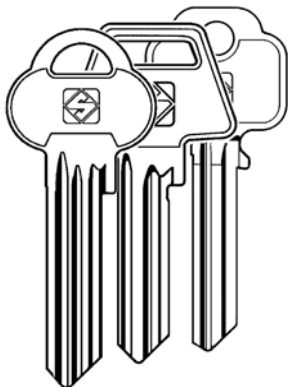

6-7 PIN KEYS

(D-12, DP, CLIQ)

OPTIONAL



OPTIONAL



OPTICAL READER
LETTORE OTTICO

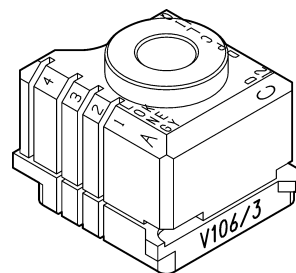

D736732ZB

V106/3 clamp for ASSA type keys (long keys, D-12*, DP, CLIQ)
Morsetto V106/3 per chiavi tipo ASSA (chiavi lunghe, D-12*, DP, CLIQ)
Spannbacke V106/3 für ASSA Schlüsseltyp (lange Schlüssel, D-12*, DP, CLIQ)
Étau V106/3 pour clés type ASSA (clés longues, D-12, DP, CLIQ)
Mordaza V106/3 para llaves de tipo ASSA (llaves largas, D-12*, DP, CLIQ)
Mordente V106/3 para chaves tipo ASSA (chaves longas, D-12*, DP, CLIQ)

*D-12: Key duplicable by code only
*D-12: Chiave duplicabile solo a codice
*D-12: Kopierenschlüssel nur zur Code
*D-12: Clé à copier uniquement par code
*D-12: Llave duplicable sólo a código

PER:
FOR: **AVA CHUBB (S)**

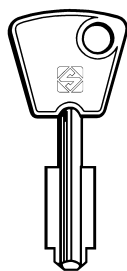

ACH

ANCHOR (S)

OPTIONAL

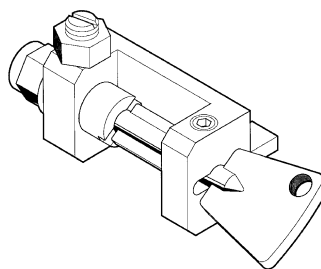

D710378ZB

*ACH adaptor
Adattatore ACH
ACH Adapter
Adaptateur ACH
Adaptadores ACH
Adaptadores ACH*

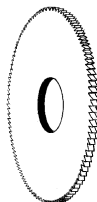

D702837ZB

*Cutter 05 (HSS)
Fresa 05 (HSS)
Fräser 05 (HSS)
Fraise 05 (HSS)
Fresa 05 (HSS)
Fresa 05 (HSS)*

D705633ZB

*Cutter 05W (hard metal)
Fresa 05W (metal duro)
Fräser 05W (Hartmetall)
Fraise 05W (au carbure)
Fresa 05W (metal duro)
Fresa 05W (metal duro)*

*It's advisable the use of hard metal cutter.
E' consigliato l'uso della fresa in metallo duro.
Die Fräser aus Hart Metall ist empfehlenswert.
Il est conseillé l'usage de la fraise au carbure.
Es recomendado el uso de la fesa en metal duro.
Recomendamos o uso de fresa en metal duro.*

PER:
FOR: **BILOCK (AUS)**

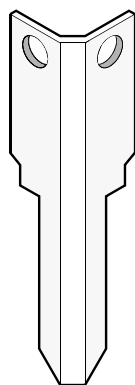

OPTIONAL

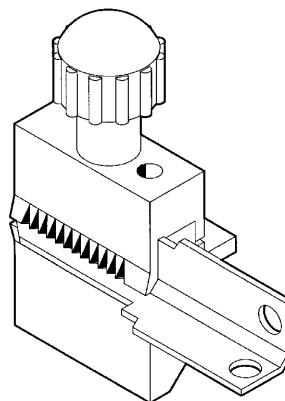

D711704ZB

*Adaptor for BILOCK keys
Set adattatore per chiavi BILOCK
Adapter für BILOCK Schlüssel
Adaptateur pour clés BILOCK
Adaptador para llaves BILOCK
Adaptador para chaves BILOCK*

PER:
FOR: **BKS (D)**

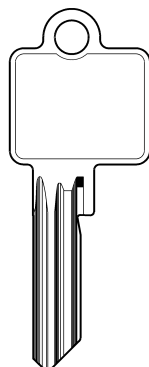

OPTIONAL

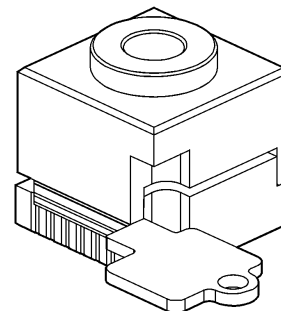

D731822ZB

*Clamp V211 for BKS type keys
Morsetto V211 per chiavi tipo BKS
Spannbacke V211 für BKS Schlüsseltyp
Etau V211 pour clés type BKS
Mordaza V211 para llaves de tipo BKS
Mordente V211 para chaves do tipo BKS*

PER:
FOR: **CHRYSLER (USA)**

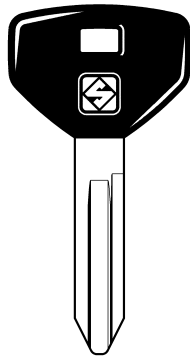

CY19P

OPTIONAL



D709576ZB
 Pair of shims
 Coppia spessori
 Passtücke
 Jeu de cales
 Par de chapas de espesor
 Par de calços

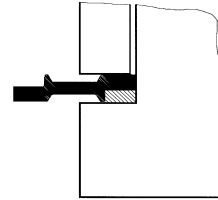
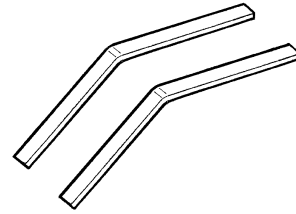

PER:
FOR: **CISA (I)**

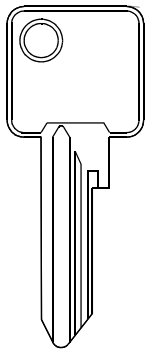

ABUS (D)

OPTIONAL



System protected by a password issued by Silca on receipt of authorization.
 Sistema protetto da Password rilasciata da Silca a fronte di autorizzazione.
 System geschützt durch von Silca geliefertes Password auf Genehmigung.
 Système protégé par un Password qui est émis par Silca sur demande d'émission.
 Sistema protegido por Password que expide Silca contra autorización.

D735434ZB
 Clamp V103 for SP/TSP type keys
 Morsetto V103 per chiavi tipo SP/TSP
 Spannbacke V103 für SP/TSP Schlüsseltyp
 Etau V103 pour clés type SP/TSP
 Mordaza V103 para llaves de tipo SP/TSP
 Mordente V103 para chaves do tipo SP/TSP

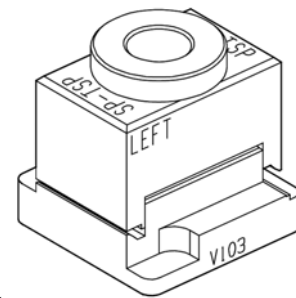

PER:
FOR: **CITROËN (F)**

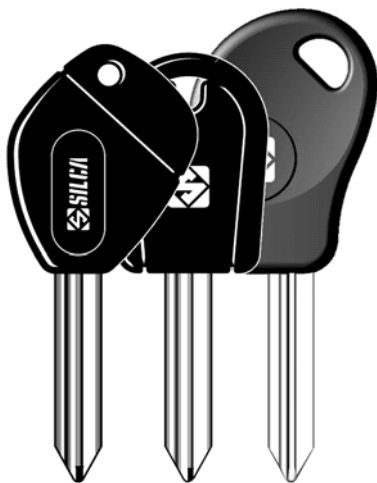

SX9CP SX9GP SX9T14
 SX9AP SX11BP SX10BP SX9T6

VALEO - SIMPLEX (F)

OPTIONAL

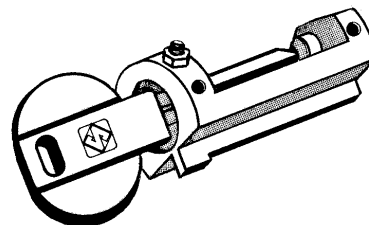

D708040ZB
 Code adaptor for SIMPLEX
 Adattatore a codice per chiavi SIMPLEX
 Code-Adapter für SIMPLEX Schlüssel
 Adaptateur à code pour clés SIMPLEX
 Adaptador a código para llaves SIMPLEX
 Adaptador por código para chaves SIMPLEX

PER:
FOR:

DOM (D)

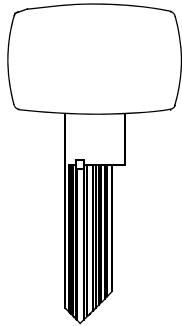

RS8
(Profil 134-135-135b-147-148)

OPTIONAL



D741046ZB

V216 clamp for DOM RS8 type keys
Morsetto V216 per chiavi tipo DOM RS8
Spannbacke V216 für DOM RS8 Schlüsseltyp
Etau V216 pour clés type DOM RS8
Mordaza V216 para llaves de tipo DOM RS8
Mordente V216 para chaves do tipo DOM RS8

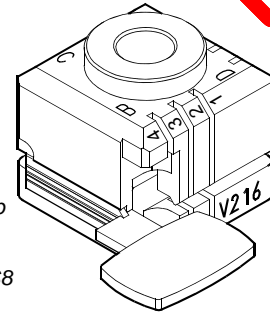

This accessory code has been updated from D735896ZB to D741046ZB.
Il codice di questo accessorio è stato aggiornato da D735896ZB a D741046ZB.
Der Kode von diesem Zubehör wurde von D735896ZB bis zum D741046ZB aktualisiert.
Le code de cet accessoire a été mis à jour de D735896ZB à D741046ZB.
El código de este accosorio ha sido actualizado de D735896ZB a D741046ZB.

PER:
FOR:

ESETY (I)

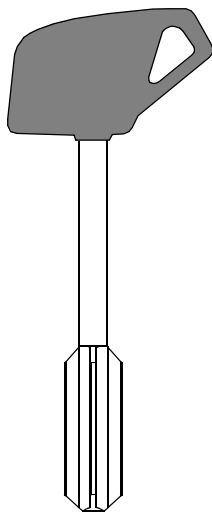

Omega

OPTIONAL

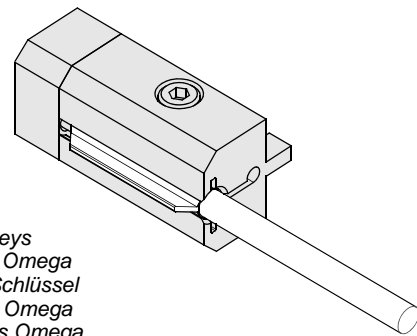

D724330ZB

B14 - Adapter for Omega keys
B14 - Adattatore per chiavi Omega
B14 - Adapter für Omega Schlüssel
B14 - Adaptateur pour clés Omega
B14 - Adaptador para llaves Omega
B14 - Adaptador para chaves Omega

System protected by a password issued by Silca on receipt of authorization.

Sistema protetto da Password rilasciata da Silca a fronte di autorizzazione.

System geschützt durch von Silca geliefertes Password auf Genehmigung.

Système protégé par un Password qui est émis par Silca sur demande d'émission.

Sistema protegido por Password que expide Silca contra autorización.

PER:
FOR:

FORD (EU)

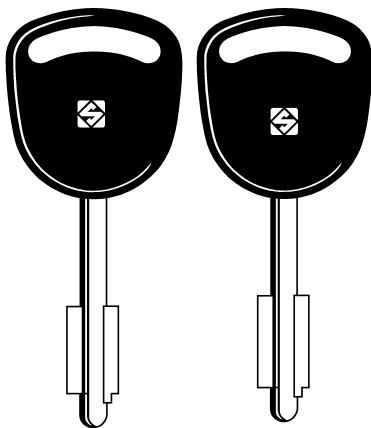

FO19P

FO20P

CHUBB (GB)

OPTIONAL

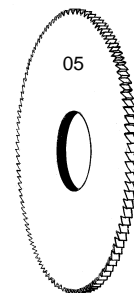
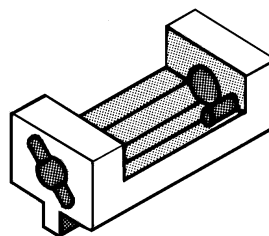

D706127ZB

Adaptor for FO19P-FO20P keys
Adattatore per chiavi FO19P-FO20P
Adapter für FO19P-FO20P Schlüssel
Adaptateur pour clés FO19P-FO20P
Adaptador para llaves FO19P-FO20P
Adaptador para chaves FO19P-FO20P

PER: **FORD (EU+USA)**
FOR:

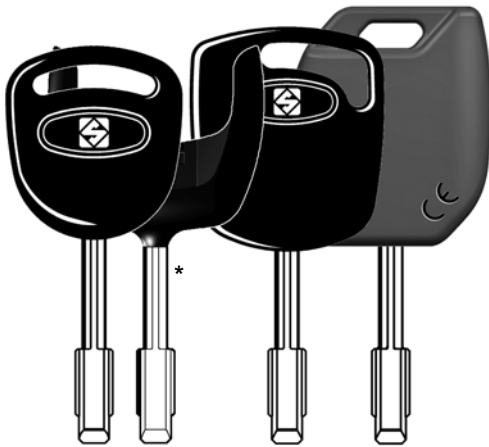

FO21P FO21AP FO21T3 FO21MH
FO21T3M
FO21T7
FO21T17
FO21TE
FO21FH

** IMPORTANT! Key blank to be applied to the original remote control (the remote control includes the transponder chip)*

TIBBE (D)
VALEO (F)

OPTIONAL

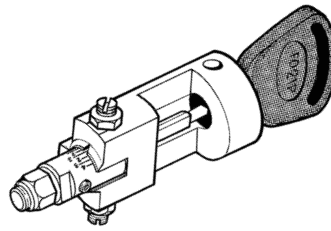

D708704ZB
Code attachment
Dispositivo a codice
Code-Vorrichtung
Dispositif à code
Dispositivo a código
Dispositivo por código

D705040ZB
Cutter 06 (HSS)
Fresa 06 (HSS)
Fräser 06 (HSS)
Fraise 06 (HSS)
Fresa 06 (HSS)
Fresa 06 (HSS)



D706128ZB
Cutter 06W (carbide)
Fresa 06W (metal duro)
Fräser 06W (Hartmetall)
Fraise 06W (au carbure)
Fresa 06W (metal duro)
Fresa 06W (metal duro)

*It's advisable the use of hard metal cutter.
E' consigliato l'uso della fresa in metallo duro.
Die Fräser aus Hart Metall ist empfehlenswert.
Il est conseillé l'usage de la fraise au carbure.
Es recomendado el uso de la fesa en metal duro.
Recomendamos o uso de fresa en metal duro.*

PER: **GEGE (A)**
FOR:

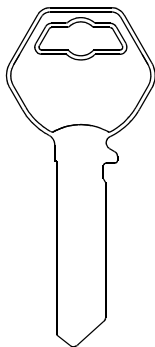

AP3000

OPTIONAL



CARD 826
SN 2878

CARD 827
SN 2879

D735433ZB
V102 - AP3000 jaw set
V102 - Morsetto per chiavi AP3000
V102 - AP3000 Spannbacken
V102 - Etau pour clés AP3000
V102 - Mordaza para llaves AP3000
V102 - Mordente para chaves AP3000

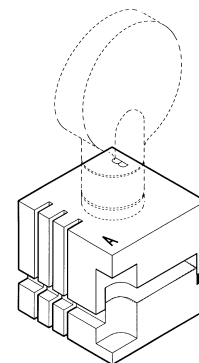

PER:
FOR: **HYUNDAI (J)**



HYN10BP

HYN10

OPTIONAL

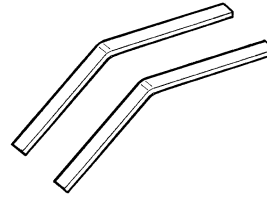

D709576ZB

Pair of shims
Coppia spessori
Passtücke
Jeu de cales
Par de chapas de espesor
Par de calços

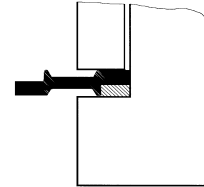

PER:
FOR: **JAGUAR (GB)**

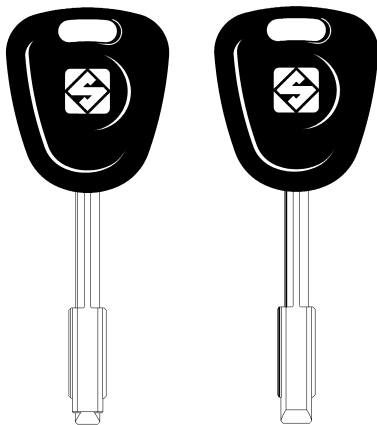

TBE1P

TBE2P

TBE1T5

TIBBE (D)
VALEO (F)

OPTIONAL

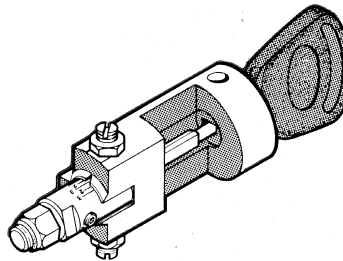

D708710ZB

Code attachment for TBE1P-TBE2P keys
Dispositivo a codice per chiavi TBE1P-TBE2P
Code-Vorrichtung für TBE1P-TBE2P Schlüssel
Dispositif à code pour clés TBE1P-TBE2P
Dispositivo a código para llaves TBE1P-TBE2P
Dispositivo por código para chaves TBE1P-TBE2P



D705040ZB

Cutter 06 (HSS)
Fresa 06 (HSS)
Fräser 06 (HSS)
Fraise 06 (HSS)
Fresa 06 (HSS)
Fresa 06 (HSS)

D706128ZB

Cutter 06W (carbide)
Fresa 06W (metal duro)
Fräser 06W (Hartmetall)
Fraise 06W (au carbure)
Fresa 06W (metal duro)
Fresa 06W (metal duro)

*It's advisable the use of hard metal cutter.
E' consigliato l'uso della fresa in metallo duro.
Die Fräser aus Hart Metall ist empfehlenswert.
Il est conseillé l'usage de la fraise au carbure.
Es recomendado el uso de la fresa en metal duro.
Recomendamos o uso de fresa en metal duro.*

PER:
FOR: **MEDECO (USA)**

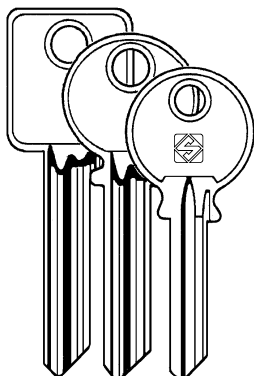

MD1R

OPTIONAL

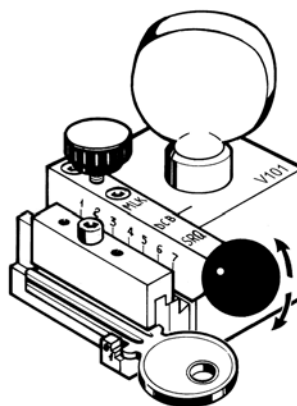

D702851ZB

Cutter
Fresa
Fräser
Fraise
Fresa
Fresa

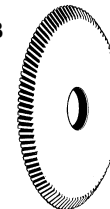

D707546ZB

Code device for MEDECO keys
Dispositivo a codice per chiavi MEDECO
Code-Vorrichtung für MEDECO Schlüssel
Dispositif à code pour clés MEDECO
Dispositivo a código para llaves MEDECO
Dispositivo por código para chaves MEDECO

PER:
FOR:

MIWA (J)

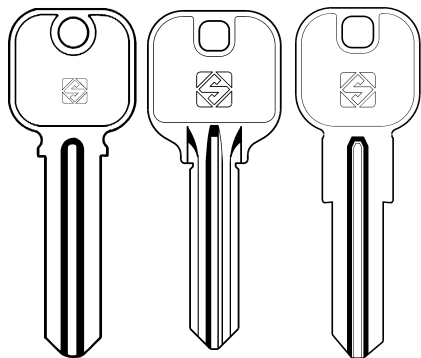

MIW1



MIW3



MIW7



MIW2



MIW12

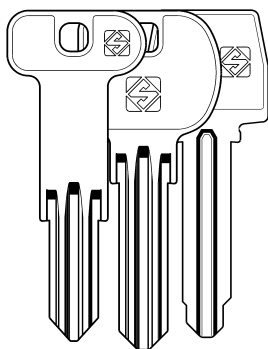

MIW4



MIW5



MIW6



MIW13

OPTIONAL

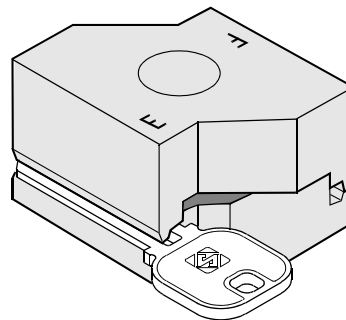

D735432ZB

V105 - Clamp for MIWA keys
V105 - Morsetto per chiavi MIWA
V105 - Spannbacken für MIWA Schlüssel
V105 - Étau pour clés MIWA
V105 - Mordaza para llaves MIWA
V105 - Mordente para chaves MIWA

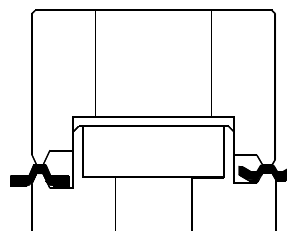

PER:
FOR:

PORSCHE (D)

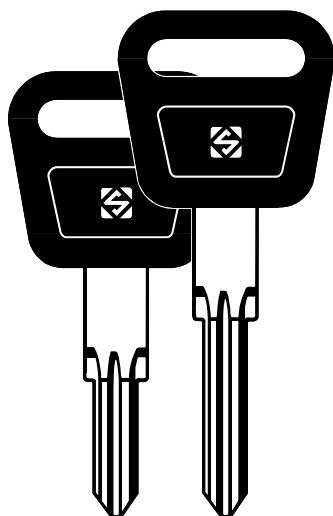

HU42P



HU45P

HUF (D)

OPTIONAL

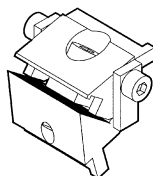

D711151ZB

Adaptor for HU42P-HU45P keys
Adattatori per chiavi HU42P-HU45P
Adapter für HU42P-HU45P Schlüssel
Adaptateur pour clés HU42P-HU45P
Adaptador para llaves HU42P-HU45P
Adaptador para chaves HU42P-HU45P

PER:
FOR:

RENAULT (F)

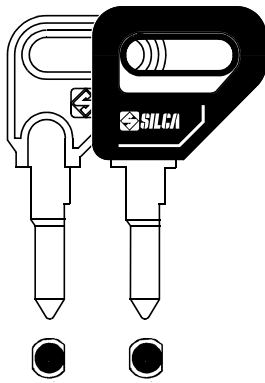

NE33S NE33SP

VALEO - NEIMAN (F)

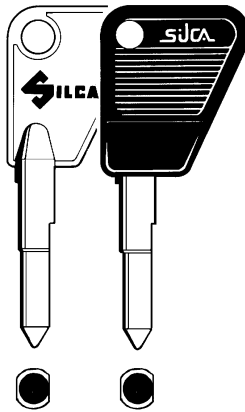

VAC64S VAC64SP

VACHETTE (F)

OPTIONAL

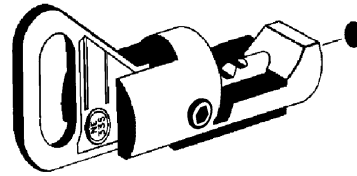

D706019ZB

Adaptor for NE33S-VAC64S keys
Adattatore per chiavi NE33S-VAC64S
Adapter für NE33S-VAC64S Schlüssel
Adaptateur pour clés NE33S-VAC64S
Adaptador para llaves NE33S-VAC64S
Adaptador para chaves NE33S-VAC64S

PER:
FOR:

WINKHAUS (D)

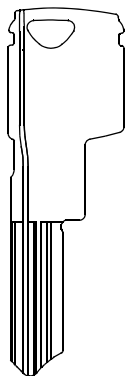

RPE - RPS

OPTIONAL



CARD 3362
SN 4262
SN 4441

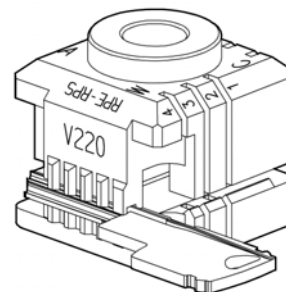

D740056ZB

Clamp V220
Morsetto V220
Spannbacken V220
Etau V220
Mordaza V220
Mordente V220

PER:
FOR:



UNOCODE PRO Unocode 399 Evo UNOCODE 399

OPTIONAL



"V1" rotating clamp

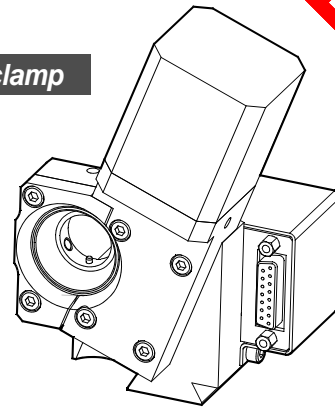

D722893ZB

"V1" rotating clamp
Morsetto girevole "V1"
Drehbarer Spannbacken "V1"
Étau pivotant "V1"
Mordaza giratoria "V1"
Mordente giratorio "V1"

KIT TOOLS FOR "V1" ROTATING CLAMP

PER:
FOR:

ABLOY (S)

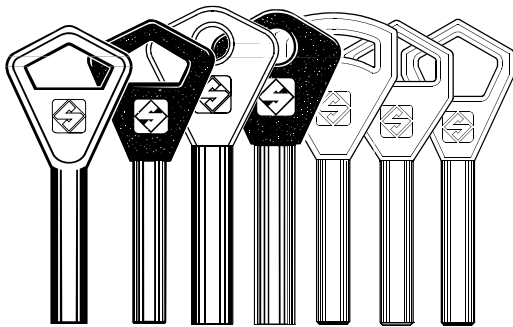

AY1 AY1P AY2 AY2P AY11 AY12 AY16
AY3 AY3P

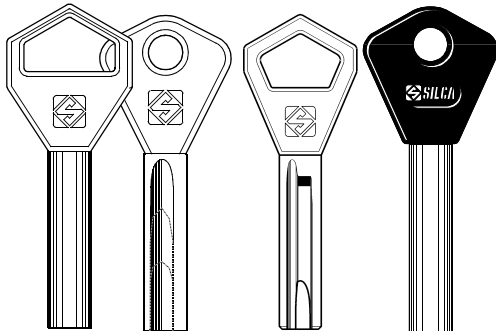

AY13 AY14 AY18 AY21
AY15 AY20 AY23 AY10P
AY17

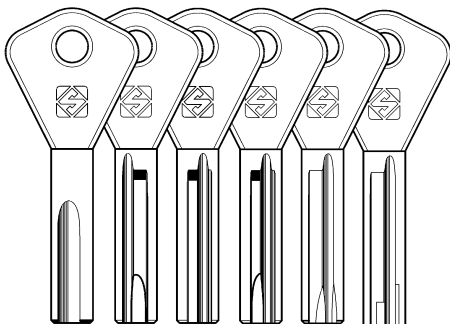

AY24 AY25 AY26 AY27 AY28 AY29

OPTIONAL

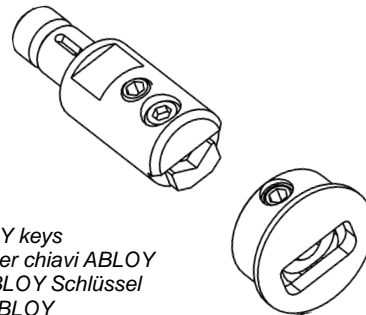

D723053ZB

Kit tools for ABLOY keys
Set contropunta per chiavi ABLOY
Werkzeuge für ABLOY Schlüssel
Outils pour clés ABLOY
Útiles para llaves ABLOY
Contra-ponta para chaves ABLOY

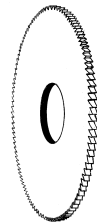

D705040ZB

Cutter 06 (HSS)
Fresa 06 (HSS)
Fräser 06 (HSS)
Fraise 06 (HSS)
Fresa 06 (HSS)
Fresa 06 (HSS)

D706128ZB

Cutter 06W (carbide)
Fresa 06W (metal duro)
Fräser 06W (Hartmetall)
Fraise 06W (au carbure)
Fresa 06W (metal duro)
Fresa 06W (metal duro)

It's advisable the use of hard metal cutter.
E' consigliato l'uso della fresa in metallo duro.
Die Fräser aus Hart Metall ist empfehlenswert.
Il est conseillé l'usage de la fraise au carbure.
Es recomendado el uso de la fesa en metal duro.
Recomendamos o uso de fresa en metal duro.

PER:
FOR:

ABUS (D)

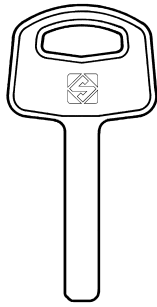

AB32

OPTIONAL

CODE

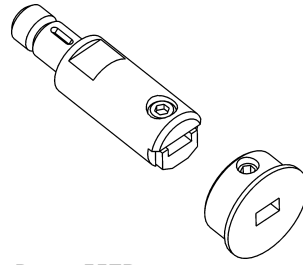

D723055ZB

Kit tools for AB32 keys
Set contropunta per chiavi AB32
Werkzeuge für AB32 Schlüssel
Outils pour clés AB32
Útiles para llaves AB32
Contraponta para chaves AB32

D705040ZB

Cutter 06 (HSS)
Fresa 06 (HSS)
Fräser 06 (HSS)
Fraise 06 (HSS)
Fresa 06 (HSS)
Fresa 06 (HSS)

D706128ZB

Cutter 06W (carbide)
Fresa 06W (metallo duro)
Fräser 06W (Hartmetall)
Fraise 06W (au carbure)
Fresa 06W (metal duro)
Fresa 06W (metal duro)

*It's advisable the use of hard metal cutter.
E' consigliato l'uso della fresa in metallo duro.
Die Fräser aus Hart Metall ist empfehlenswert.
Il est conseillé l'usage de la fraise au carbure.
Es recomendado el uso de la fesa en metal duro.
Recomendamos o uso de fresa en metal duro.*

PER:
FOR:

ABUS (D)



AB38P

AB60P

IMPORTANT!

Patented key, please contact Silca for information.
Chiave brevettata, rivolgersi a Silca per informazioni.
Patentierter Schlüssel, Bitte, für Informationen an Silca sich wenden.
Clé brevetée, contacter Silca pour information.
Llave patentada, contactar Silca para informaciones.

OPTIONAL

CODE

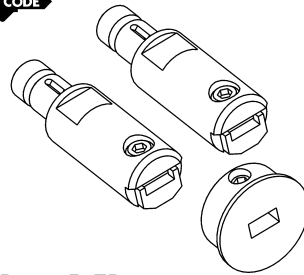

D723057ZB

Kit tools for AB38P-AB60P keys
Set contropunta per chiavi AB38P-AB60P
Werkzeuge für AB38P-AB60P Schlüssel
Outils pour clés AB38P-AB60P
Útiles para llaves AB38P-AB60P
Contraponta para chaves AB38P-AB60P

*It's advisable the use of hard metal cutter.
E' consigliato l'uso della fresa in metallo duro.
Die Fräser aus Hart Metall ist empfehlenswert.
Il est conseillé l'usage de la fraise au carbure.
Es recomendado el uso de la fesa en metal duro.
Recomendamos o uso de fresa en metal duro.*

AB60P

D712450ZB

Cutter SG13 (HSS)
Fresa SG13 (HSS)
Fräser SG13 (HSS)
Fraise SG13 (HSS)
Fresa SG13 (HSS)

D723158ZB

Cutter SG13W (carbide)
Fresa SG13W (metallo duro)
Fräser SG13W (Hartmetall)
Fraise SG13W (au carbure)
Fresa SG13W (metal duro)

AB38P

D705040ZB

Cutter 06 (HSS)
Fresa 06 (HSS)
Fräser 06 (HSS)
Fraise 06 (HSS)
Fresa 06 (HSS)

D706128ZB

Cutter 06W (carbide)
Fresa 06W (metallo duro)
Fräser 06W (Hartmetall)
Fraise 06W (au carbure)
Fresa 06W (metal duro)

PER:
FOR:

AVA CHUBB (S)

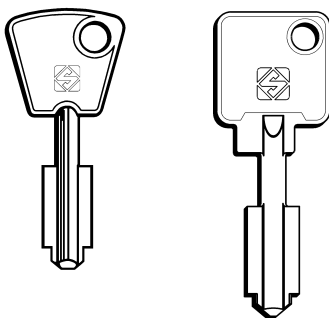

ACH

5ACH4

OPTIONAL

CODE

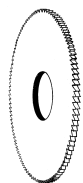

D723043ZB

Kit tools for AVA CHUBB keys
Set contropunta per chiavi AVA CHUBB
Werkzeuge für AVA CHUBB Schlüssel
Outils pour clés AVA CHUBB
Útiles para llaves AVA CHUBB
Contraponta para chaves AVA CHUBB

D702837ZB

Cutter 05 (HSS)
Fresa 05 (HSS)
Fräser 05 (HSS)
Fraise 05 (HSS)
Fresa 05 (HSS)

D705633ZB

Cutter 05W (carbide)
Fresa 05W (metallo duro)
Fräser 05W (Hartmetall)
Fraise 05W (au carbure)
Fresa 05W (metal duro)

*It's advisable the use of hard metal cutter.
E' consigliato l'uso della fresa in metallo duro.
Die Fräser aus Hart Metall ist empfehlenswert.
Il est conseillé l'usage de la fraise au carbure.
Es recomendado el uso de la fesa en metal duro.
Recomendamos o uso de fresa en metal duro.*

PER:
FOR:

ANCHOR LÅS (S)

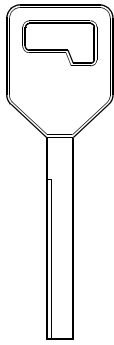

OPTIONAL



D723049ZB

Kit tools for ANCHOR-LÅS keys
Set contropunta per chiavi ANCHOR-LÅS
Werkzeuge für ANCHOR-LÅS Schlüssel
Outils pour clés ANCHOR-LÅS
Útiles para llaves ANCHOR-LÅS
Contra-ponta para chaves ANCHOR-LÅS

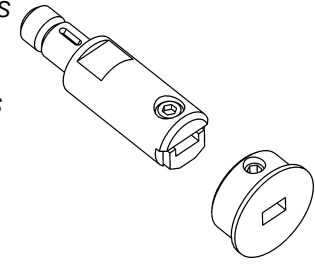

D705040ZB

Cutter 06 (HSS)
Fresa 06 (HSS)
Fräser 06 (HSS)
Fraise 06 (HSS)
Fresa 06 (HSS)
Fresa 06 (HSS)



D706128ZB

Cutter 06W (carbide)
Fresa 06W (metallo duro)
Fräser 06W (Hartmetall)
Fraise 06W (au carbure)
Fresa 06W (metal duro)
Fresa 06W (metal duro)

*It's advisable the use of hard metal cutter.
E' consigliato l'uso della fresa in metallo duro.
Die Fräser aus Hart Metall ist empfehlenswert.
Il est conseillé l'usage de la fraise au carbure.
Es recomendado el uso de la fresa en metal duro.
Recomendamos o uso de fresa en metal duro.*

PER:
FOR:

CHUBB (GB)

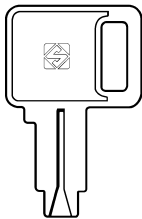

CHU5

OPTIONAL



D723160ZB

Kit tools for CHU5 keys
Set contropunta per chiavi CHU5
Werkzeuge für CHU5 Schlüssel
Outils pour clés CHU5
Útiles para llaves CHU5
Contra-ponta para chaves CHU5

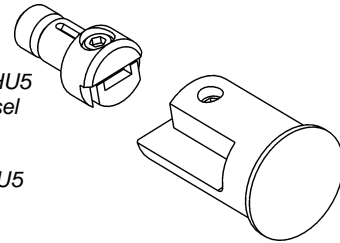

D702837ZB

Cutter 05 (HSS)
Fresa 05 (HSS)
Fräser 05 (HSS)
Fraise 05 (HSS)
Fresa 05 (HSS)
Fresa 05 (HSS)

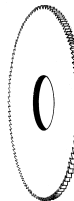

D705633ZB

Cutter 05W (carbide)
Fresa 05W (metallo duro)
Fräser 05W (Hartmetall)
Fraise 05W (au carbure)
Fresa 05W (metal duro)
Fresa 05W (metal duro)

*It's advisable the use of hard metal cutter.
E' consigliato l'uso della fresa in metallo duro.
Die Fräser aus Hart Metall ist empfehlenswert.
Il est conseillé l'usage de la fraise au carbure.
Es recomendado el uso de la fresa en metal duro.
Recomendamos o uso de fresa en metal duro.*

PER:
FOR:

FORD (EU)

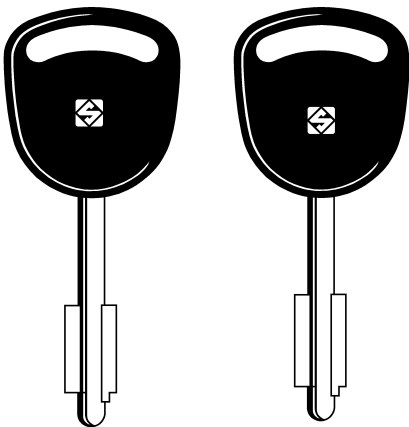

FO19P

FO20P

CHUBB (GB)

OPTIONAL



D723051ZB

Kit tools for FO19P-FO20P keys
Set contropunta per chiavi FO19P-FO20P
Werkzeuge für FO19P-FO20P Schlüssel
Outils pour clés FO19P-FO20P
Útiles para llaves FO19P-FO20P
Contra-ponta para chaves FO19P-FO20P

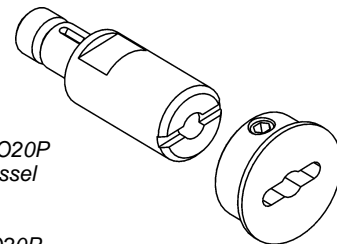

D702837ZB

Cutter 05 (HSS)
Fresa 05 (HSS)
Fräser 05 (HSS)
Fraise 05 (HSS)
Fresa 05 (HSS)
Fresa 05 (HSS)



D705633ZB

Cutter 05W (carbide)
Fresa 05W (metallo duro)
Fräser 05W (Hartmetall)
Fraise 05W (au carbure)
Fresa 05W (metal duro)
Fresa 05W (metal duro)

*It's advisable the use of hard metal cutter.
E' consigliato l'uso della fresa in metallo duro.
Die Fräser aus Hart Metall ist empfehlenswert.
Il est conseillé l'usage de la fraise au carbure.
Es recomendado el uso de la fresa en metal duro.
Recomendamos o uso de fresa en metal duro.*

PER:
FOR:

FORD (EU+USA)

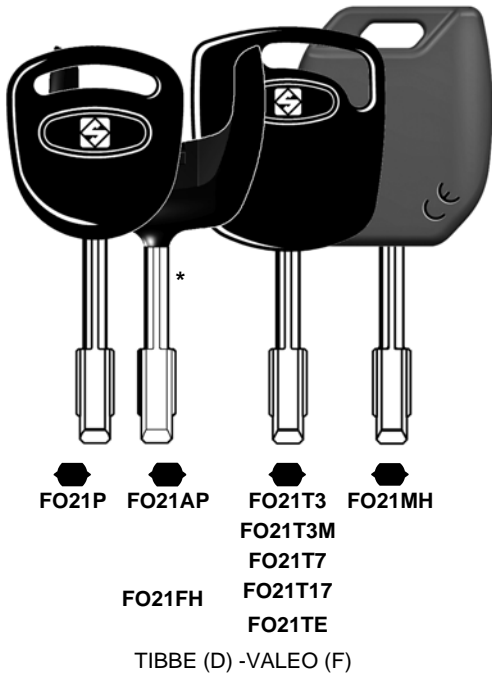

OPTIONAL



D723059ZB

Kit tools for FO21P keys
Set contropunta per chiavi FO21P
Werkzeuge für FO21P Schlüssel
Outils pour clés FO21P
Útiles para llaves FO21P
Contraponta para chaves FO21P

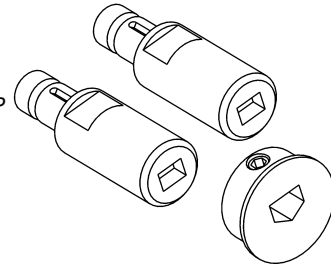

D705040ZB

Cutter 06 (HSS)
Fresa 06 (HSS)
Fräser 06 (HSS)
Fraise 06 (HSS)
Fresa 06 (HSS)
Fresa 06 (HSS)



D706128ZB

Cutter 06W (carbide)
Fresa 06W (metallo duro)
Fräser 06W (Hartmetall)
Fraise 06W (au carbure)
Fresa 06W (metal duro)
Fresa 06W (metal duro)

*It's advisable the use of hard metal cutter.
E' consigliato l'uso della fresa in metallo duro.
Die Fräser aus Hart Metall ist empfehlenswert.
Il est conseillé l'usage de la fraise au carbure.
Es recomendado el uso de la fesa en metal duro.
Recomendamos o uso de fresa en metal duro.*

PER:
FOR:

JAGUAR (GB)

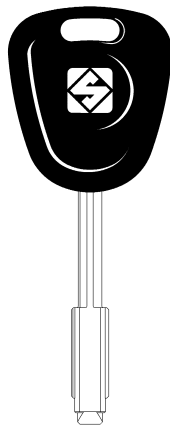

TBE1P
TBE2P
TBE1T5

TIBBE (D) - VALEO (F)

OPTIONAL



D723059ZB

Kit tools for TBE1P-TBE2P keys
Set contropunta per chiavi TBE1P-TBE2P
Werkzeuge für TBE1P-TBE2P Schlüssel
Outils pour clés TBE1P-TBE2P
Útiles para llaves TBE1P-TBE2P
Contraponta para chaves TBE1P-TBE2P

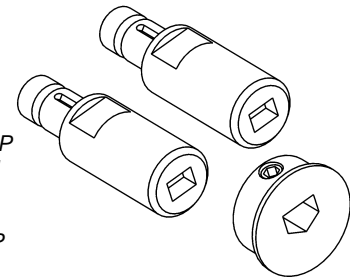

D705040ZB

Cutter 06 (HSS)
Fresa 06 (HSS)
Fräser 06 (HSS)
Fraise 06 (HSS)
Fresa 06 (HSS)
Fresa 06 (HSS)

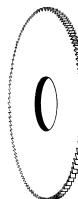

D706128ZB

Cutter 06W (carbide)
Fresa 06W (metallo duro)
Fräser 06W (Hartmetall)
Fraise 06W (au carbure)
Fresa 06W (metal duro)
Fresa 06W (metal duro)

*It's advisable the use of hard metal cutter.
E' consigliato l'uso della fresa in metallo duro.
Die Fräser aus Hart Metall ist empfehlenswert.
Il est conseillé l'usage de la fraise au carbure.
Es recomendado el uso de la fesa en metal duro.
Recomendamos o uso de fresa en metal duro.*

PER:
FOR:

LUMA (E)

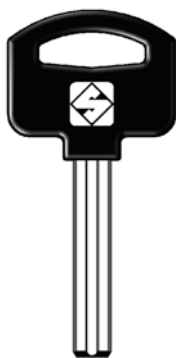

LM5P

OPTIONAL



D723045ZB

Kit tools for LM5P keys
Set contropunta per chiavi LM5P
Werkzeuge für LM5P Schlüssel
Outils pour clés LM5P
Útiles para llaves LM5P
Contraponta para chaves LM5P

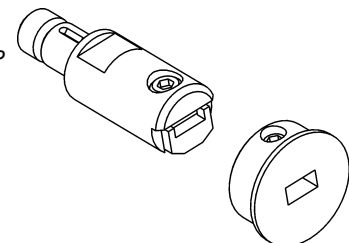

D705040ZB

Cutter 06 (HSS)
Fresa 06 (HSS)
Fräser 06 (HSS)
Fraise 06 (HSS)
Fresa 06 (HSS)
Fresa 06 (HSS)



D706128ZB

Cutter 06W (carbide)
Fresa 06W (metallo duro)
Fräser 06W (Hartmetall)
Fraise 06W (au carbure)
Fresa 06W (metal duro)
Fresa 06W (metal duro)

*It's advisable the use of hard metal cutter.
E' consigliato l'uso della fresa in metallo duro.
Die Fräser aus Hart Metall ist empfehlenswert.
Il est conseillé l'usage de la fraise au carbure.
Es recomendado el uso de la fesa en metal duro.
Recomendamos o uso de fresa en metal duro.*

PER:
FOR:



UNOCODE PRO Unocode 399 Evo UNOCODE 399

Cutting flat keys
Cifratura chiavi piatte
Fräsen von Flachschlüsseln
Taillage de clés plates
Duplicación de llaves planas

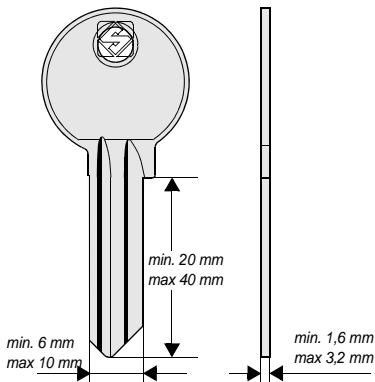

IMPORTANT NOTE:
in order to use the automatic key feeder with keys characterized by dimensions closed to the min./max indicated please contact Silca Technical Assistance Dept.

OPTIONAL



Automatic key feeder - Set caricatore di chiavi piatte - Grundzuführung
Set Alimentateur de clés plates - Alimentador de llaves planas

D717228ZB

Automatic key feeder
Set caricatore di chiavi piatte
Grundzuführung
Alimentateur de clés plates
Alimentador de llaves planas
Carregador de chaves planas

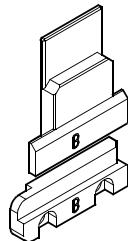
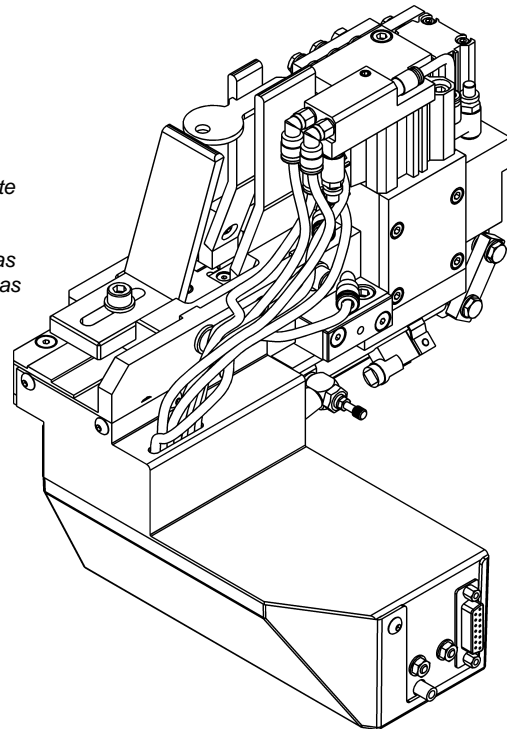

D721322ZB

"B side" jaw set
Set ganasce "lato B"
Backen "Seite B"
Mâchoires "côté B"
Quijadas "lado B"
Garras "lado B"

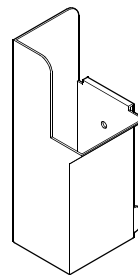

for Unocode 399

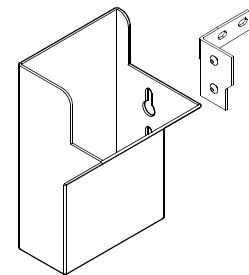

for: Unocode PRO
Unocode 399 EVO

TECHNICAL DATA - CARATTERISTICHE TECNICHE - TECHNISCHE DATEN - CARACTERISTIQUES TECHNIQUES - DATOS TÉCNICOS

Working - Funzionamento - Funktionsweise Fonctionnement - Funcionamiento	by compressed air* - collegamento ad aria compressa* - mit Druckluft* - avec air comprimé* - con aire comprimido* 0,5 - 0,6 MPa					
Dimensions - Dimensioni - Abmessungen Encombrement - Dimensiones	width - larghezza - Breite largeur - anchura	230 mm	height - altezza - Höhe hauteur - altura	220 mm	depth - profondità - Tiefe profondeur - profundidad	200 mm
Mass - Massa - Gewicht - Poids - Masa	Kg. 5,5					

* Not supplied - Non in dotazione - Nicht Zubehör - Non fourni - No en el equipamiento

PER:
FOR:

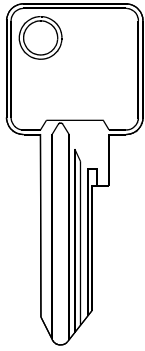

"SP" "TSP"

ABUS

OPTIONAL



D723136ZB

Tool set for SP - TSP type keys
Set attrezzatura per chiavi SP - TSP
Werkzeug für SP - TSP Schlüsseltyp
Set outils pour clés de type SP - TSP
Accesorios para llaves SP - TSP
Acessorios para chaves SP - TSP

To fit on automatic key feeder
Da applicare al caricatore di chiavi
Auf Grundzuführung zu installieren
A installer sur l'alimentateur de clés
A instalarse en alimentador de llaves
A ser aplicada ao carregador de chaves

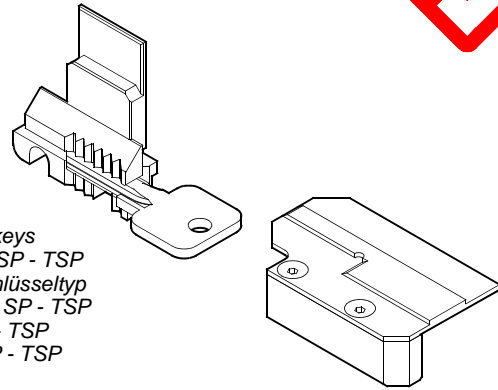

PER:
FOR:

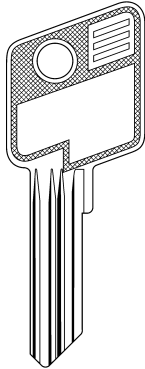

EVVA DPS

OPTIONAL



D723123ZB

Tool set for EVVA "DPS" keys
Set attrezzatura per chiavi EVVA "DPS"
Werkzeug für EVVA "DPS" Schlüsseltyp
Set outils pour clés de type EVVA "DPS"
Accesorios para llaves EVVA "DPS"
Acessorios para chaves EVVA "DPS"

To fit on automatic key feeder
Da applicare al caricatore di chiavi
Auf Grundzuführung zu installieren
A installer sur l'alimentateur de clés
A instalarse en alimentador de llaves
A ser aplicada ao carregador de chaves

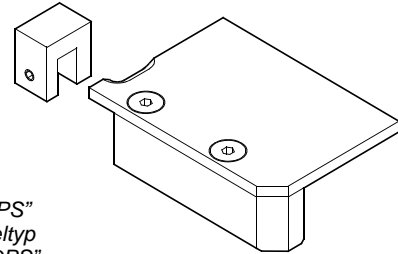

PER:
FOR:



UNOCODE PRO
Unocode 399 Evo
UNOCODE 399

OPTIONAL

Swarf vacuum set

D722823ZB

Swarf vacuum set
Set aspirazione trucioli
Späneabsaugungssatz
Ensemble d'aspiration des copeaux
Conjunto aspiracion de virutas
Kit aspirador de limalhas



PER:
FOR:



UNOCODE PRO **Unocode 399 Evo**

OPTIONAL

Swarf tray for vacuum system

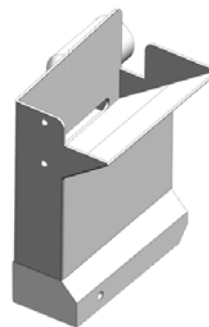

D735714ZB

*Swarf tray for vacuum system
Kit vaschetta in metallo per aspiratrucioli
Splitterschutz für für Späneabsaugung
Cuvette à copeaux pour kit d'aspiration
Cubeta virutas para aspiración
Recipiente para limalhas*